

OPERATION MANUAL

CLASSIC 10 and CLASSIC 18

SERIAL NUMBER FROM JANUARY 2009 (0109) TO PRESENT



**READ THIS MANUAL CAREFULLY FOR INSTRUCTIONS ON CORRECT
INSTALLATION AND USAGE, AND READ ALL SAFEGUARDS**

SECCIÓN EN ESPAÑOL
SECTION EN FRANÇAIS
AVAILABLE AT WWW.MOVINCOOL.COM



MOVINCOOL®
THE #1 SPOT COOLING SOLUTION

© 2009 DENSO SALES CALIFORNIA, INC.

All rights reserved. This book may not be reproduced or copied, in whole or in part, without the written permission of the publisher.

DENSO SALES CALIFORNIA, INC. reserves the right to make changes without prior notice. MovinCool is a registered trademark of DENSO Corporation.

OPERATION MANUAL

CLASSIC 10 and CLASSIC 18

MOVINCOOL®
THE #1 SPOT COOLING SOLUTION

Table of Contents

FOREWORD	5
Definition of Terms	5
GENERAL WARNINGS & CAUTIONS	6
INVENTORY & ASSEMBLY	7
Inventory	7
Assembly	8
INSTALLATION	9
Choosing an Installation Site	9
Moving the Unit	10
Plugging in the Unit	11
Warning Signal Connection	12
Fire Alarm Control Panel Connection	13
LCDI Power Cord Instruction	14
FEATURES	15
OPERATION	16
Control Panel	16
LED Display Descriptions	17
Operating in COOL Mode	18
Operating in FAN ONLY Mode	19
Changing from FAN ONLY Mode to COOL Mode	19
Operating Modes	20
Self-Diagnostic Codes	21
Empty the Drain Tank	22
Condensate Pump Kit (Optional for Classic 10)	23
Condensate Pump Kit (Optional for Classic 18)	24
DAILY INSPECTION & MAINTENANCE	25
Empty the Drain Tank	25
Clean the Air Filters	25
Filter Removal Method	25
Filter Element Cleaning Method	25
In-Season/Off-Season Inspection & Maintenance	26
TROUBLESHOOTING	27
TECHNICAL SPECIFICATONS	28

FOREWORD

Congratulations on purchasing the MovinCool portable air conditioner. This manual explains how to install and operate the MovinCool Classic 10, and Classic 18 portable air conditioning units. Please read this operation manual thoroughly to familiarize yourself with the features of the unit and to ensure years of reliable operation.

You may also find it useful to keep this operation manual on hand for reference. Components and/or procedures are subject to change without prior notice.

Definition of Terms



WARNING: Describes precautions that should be observed in order to prevent injury to the user during installation or unit operation.



CAUTION: Describes precautions that should be observed in order to prevent damage to the unit or its components, which may occur during installation or unit operation if sufficient care is not taken.

Note: Provides additional information that facilitates installation or unit operation.

GENERAL WARNINGS & CAUTIONS

1. All electrical work, if necessary, should only be performed by qualified electrical personnel. Repair to electrical components by non-certified technicians may result in personal injury and/or damage to the unit. All electrical components replaced must be genuine MovinCool parts, purchased from an authorized reseller.
2. The proper electrical outlet for MovinCool units must be equipped with a UL approved circuit breaker.
3. Because of potential safety hazards under a certain condition, we strongly recommend against the use of an extension cord. However, if you still elect to use an extension cord, it is absolutely necessary that it is a UL listed, 3-wire grounding type appliance extension cord, having a 3-blade grounding plug and a 3-slot receptacle that plugs into the appliance. The marked rating of the extension cord should be 115 V, 15 A for Classic 10, and 230 V, 15 A for Classic 18 or equivalent.
4. The Classic 10 is equipped with a 10 ft (3.0 m) UL approved LCDI power cord. The Classic 18 is equipped with a 6 ft (1.8 m) UL approved LCDI power cord. For replacement, fixed location (hardwire) or power cord lengthening (extension cord) cords are required, contact your MovinCool reseller or a qualified electrician for approved replacement methods.
5. Never fold or place heavy objects on the power cord. This could result in damage to the power cord causing electrical shock or fire.
6. Do not place water or any other liquid on the unit. This can cause damage to the unit and increase the risk of electrical shock.
7. Do not sit or stand on the unit.

INVENTORY & ASSEMBLY

Inventory

After unpacking your MovinCool unit, please check to make sure you have the following items:

1. **Classic 10 or Classic 18 MovinCool Unit (1)**
2. **Cool Air Outlet Duct(s) (Classic 10 qty. = 1, Classic 18 qty. = 2)**
3. **Screws (Classic 10 qty. = 4, Classic 18 qty. = 8)**
4. **Operation Manual/Product Registration (1)**

Note: If any of these items were not included in the box or appear damaged, please contact your MovinCool reseller for replacement.

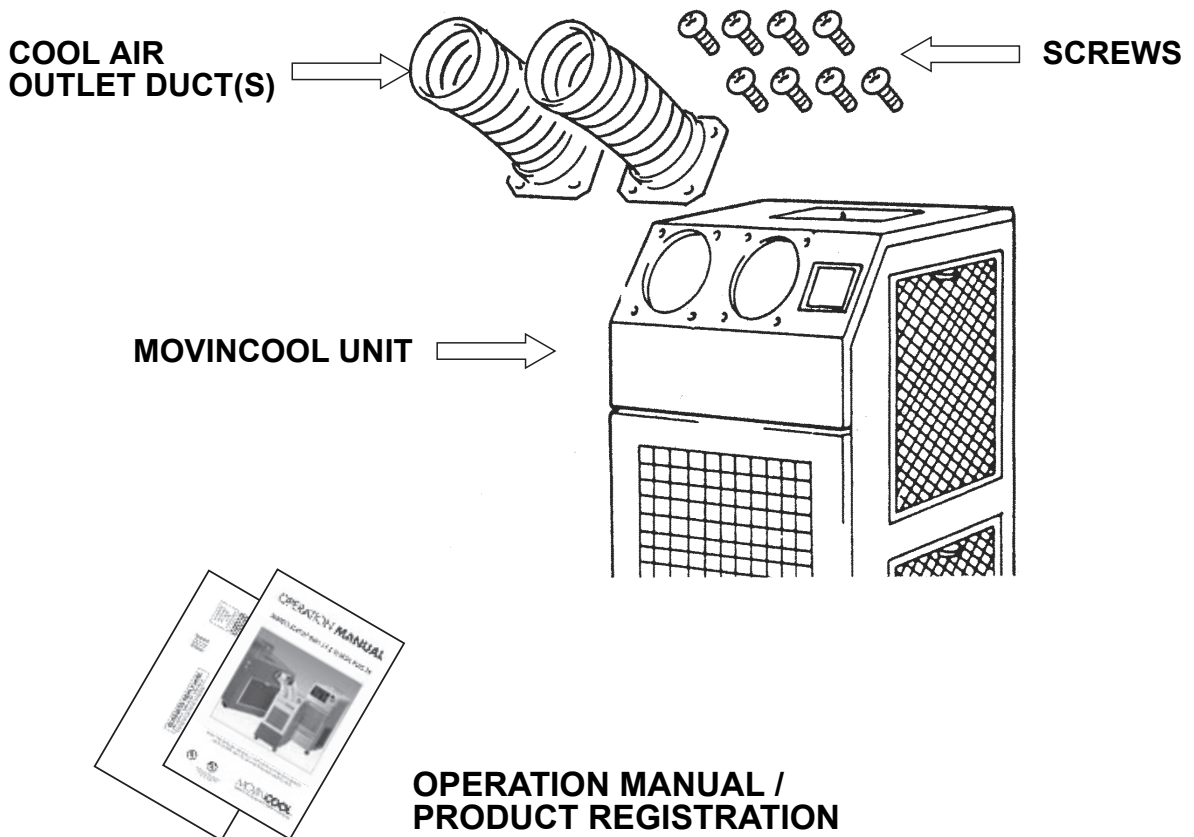

INVENTORY & ASSEMBLY (cont.)

Assembly

 **CAUTION:** Before assembling make sure the unit is on a flat, level surface and the casters are in the **LOCKED** position. (Both the Classic 10 and Classic 18 MovinCool units have locking swivel casters in the front only.)

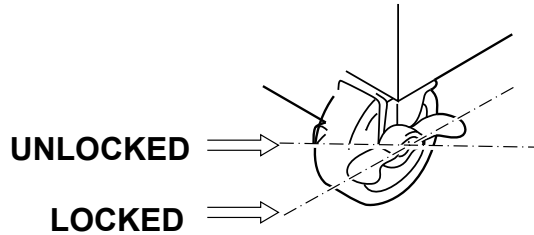

Install each cool air outlet duct using 4 screws each as shown.

Note: Do not over tighten the screws when installing the cool air outlet ducts. This could damage the base on the cool air outlet duct assembly.

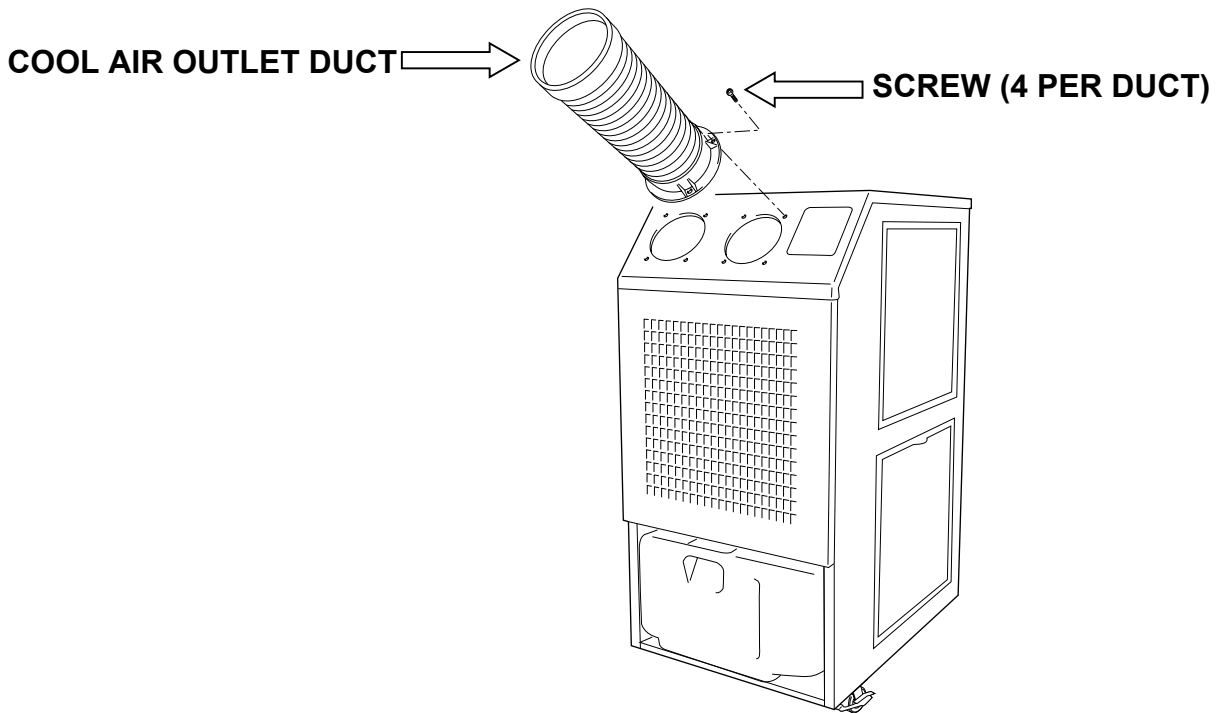

INSTALLATION

Choosing an Installation Site



CAUTION: Following are some precautions to consider before choosing your installation site. Please review carefully as improper installation may result in personal injury or damage to the unit.

1. Do not use the unit in areas where leakage of flammable gas may occur.
2. Do not use the unit in areas where it is exposed to rain or water.
3. Do not use the unit in an atmosphere of excessively corrosive gas or vapor.
4. Do not use in areas where the temperature is outside the allowable operating range.
5. Do not install the unit in sloping areas. The unit may move or topple over even if the casters are set to the LOCKED position.
6. Install the unit in areas that can with-stand the weight of the unit. The Classic 10 unit weighs approximately 184 lb (83 kg), and the Classic 18 unit weighs approximately 199 lb (90 kg) when the drain tank is full of water.
7. Allow 18.0 in (457 mm) of unobstructed airflow for both the air inlets and outlets.
8. Do not use the unit at condition above 104 °F (40 °C) 50 %RH.

INSTALLATION (cont.)

Moving the Unit

Unlock the casters and push the MovinCool unit to a flat level surface and set the casters back to the LOCKED position.

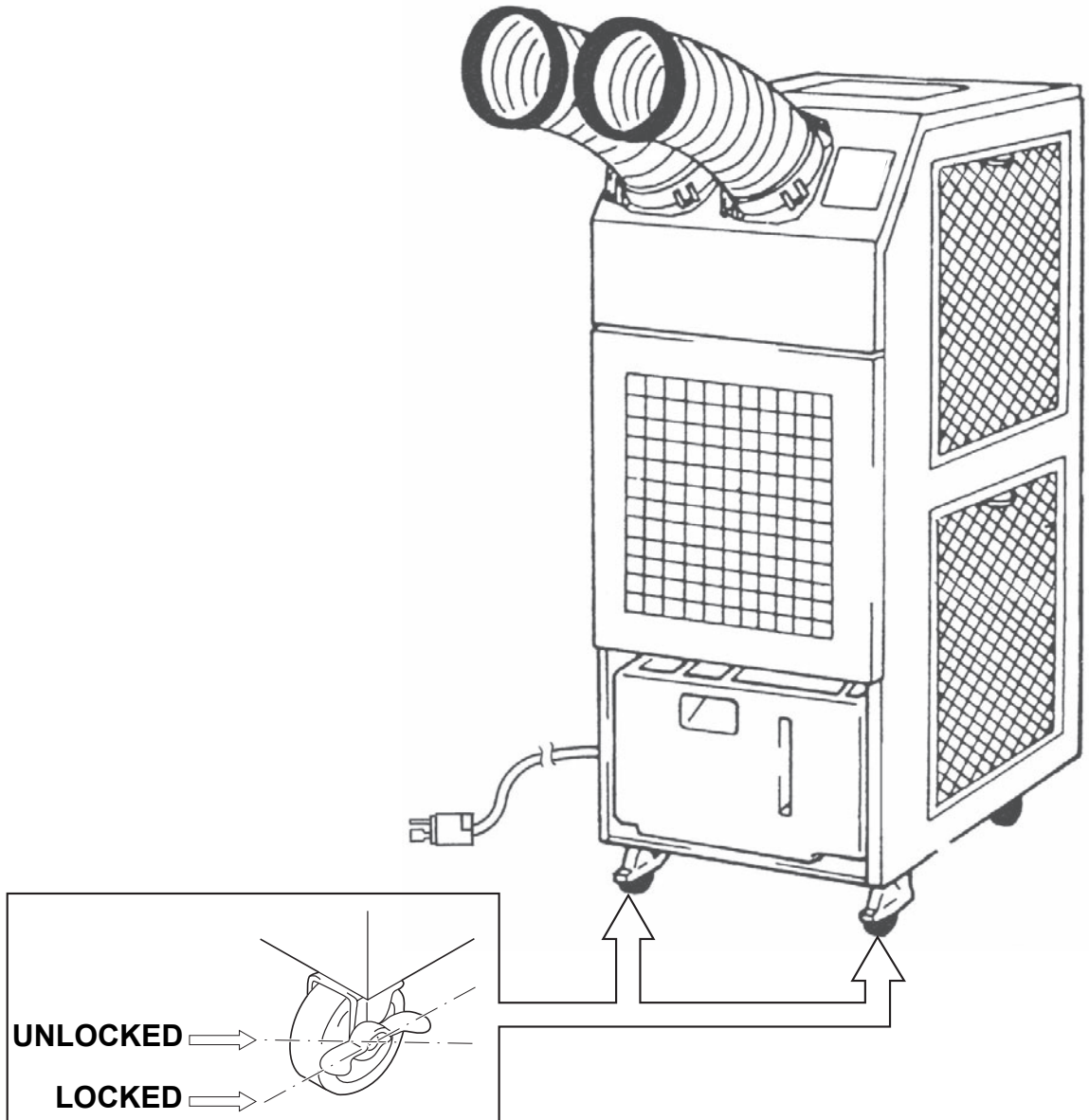

INSTALLATION (cont.)

Plugging in the Unit

1. Check the prongs and surface of the power cord plug for dust/dirt. If dust and/or dirt are present, wipe off with a clean, dry cloth.
2. Check the power cord, plug and prongs for damage or excess play. If any damage or excess play is found, contact your MovinCool reseller or a qualified technician for repair.



WARNING:

1. **If the power cord or plug is damaged, repair should only be performed by qualified electrical personnel.**
2. **Do not connect/disconnect the power cord or attempt to operate buttons with wet hands. This could result in electrical shock.**



CAUTION:

1. **Classic 10 ONLY: The AC outlet (115 VAC Single Phase, 60 Hz) needs to be rated at 15 A or higher. Do not share the outlet with any other instrument or equipment.**
2. **Classic 18 ONLY: The AC outlet (208/230 VAC Single Phase, 60 Hz) needs to be rated at 15 A or higher. Do not share the outlet with any other instrument or equipment.**

Note:

1. *Make sure the AC outlet is free of dirt, dust, oil, water, or any other foreign matter.*
2. *The Classic 10 is equipped with a UL approved LCDI cord and an approved NEMA plug configuration (5-15). The appropriate outlet must be used for this plug type.*
3. *The Classic 18 is equipped with a UL approved LCDI cord and an approved NEMA plug configuration (6-15). The appropriate outlet must be used for this plug type.*

INSTALLATION (cont.)

Warning Signal Connection (Output Signal Terminal L+ and L-)

The controller is equipped with a warning signal output relay type (Form C, normal open dry contact) which can be used to monitor the failure condition.

Relay contactor is closed when the following condition has occurred:

- a. Tank full
- b. Temperature sensor fails

The relay output contactor is rated 2 A at 30 VDC or 2 A at 30 VAC (resistive load) and it is compatible with various warning devices such as alarm speaker, light indicators, and etc.

Connecting Warning Signal From Controller

1. Remove service panel from the rear of the unit.
2. Squeeze the inner latches and push out the black cap from inside the panel.

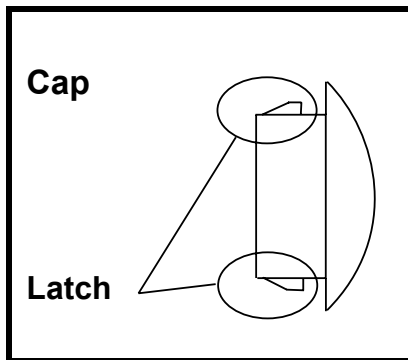

3. Use recommended warning signal wire size from 16 AWG to 26 AWG for a solid wire, or 16 AWG to 22 AWG for a stranded wire with ring terminal for #6 stud size.
4. Connect warning device to terminal L+ and L- according to its polarities.

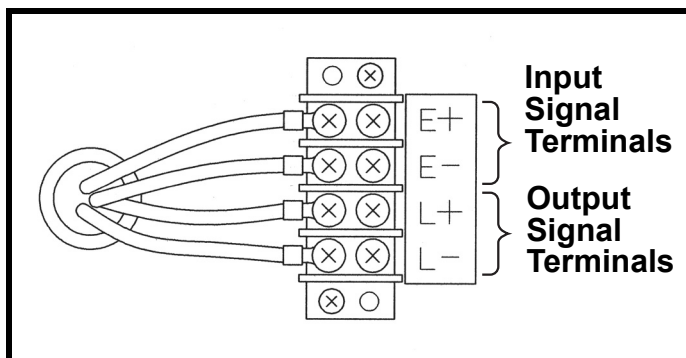

INSTALLATION (cont.)

Fire Alarm Control Panel Connection (Input Signal Terminal E+ and E-)

The controller is equipped with a normal open input signal, which can be connected directly from the fire alarm control panel. This input signal terminal should only be connected to a close or open dry contact signal. When receiving the signal from the fire alarm control panel, the unit turns off and does not turn back on until it has been RESET.

Connecting Fire Alarm Control Panel to Controller

1. Remove service panel from the rear of the unit.
2. Squeeze the inner latches and push out the black cap from inside the panel.

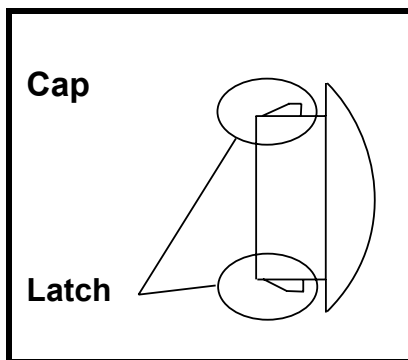

3. Use recommended warning signal wire size from 16 AWG to 26 AWG for a solid wire, or 16 AWG to 22 AWG for a stranded wire with ring terminal for #6 stud size.
4. Connect warning device to terminal E+ and E- according to its polarities.

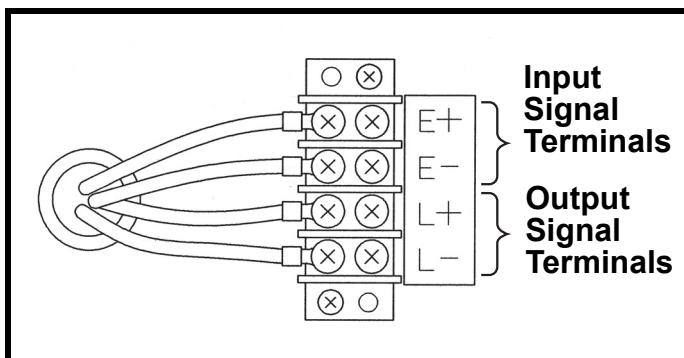

INSTALLATION (cont.)

LCDI Power Cord Instruction

WARNING

The LCDI device is a non-serviceable device. Attempting to open the device may expose the user to the hazards of electric shock, and could void warranties of this product. Manufacturer's liability is limited to the replacement of the device.

CAUTION

1. Read the attention printed on the device for proper use and handling of this device.
2. This device is used for monitoring leakage current.
3. Do not immerse in water.
4. This device must only be plugged into an appropriate wall outlet. Do not use on extension cords or adapter. Do not remove ground prong.
5. In the event that this device trips, the cause of malfunction should be corrected first before further use.
6. Using the device beyond recommended voltage poses risk to users.
7. Conductors inside this cord are surrounded by shields, which monitor leakage current. These shields are not grounded, and the cords are periodically examined for any damage. Do not use this product in the event the shields become exposed.
8. Do not push TEST and/or RESET buttons in a short period.

Procedure

Test device once when AC is installed to assure proper operation.

1. Plug into grounded power receptacle.
2. If light is not on, press RESET button once. Light should turn on.
3. Press TEST button once, light must turn off.
4. Press RESET button once again for use. Light should turn on.
5. If test fails, do not use.

<FRONT VIEW>

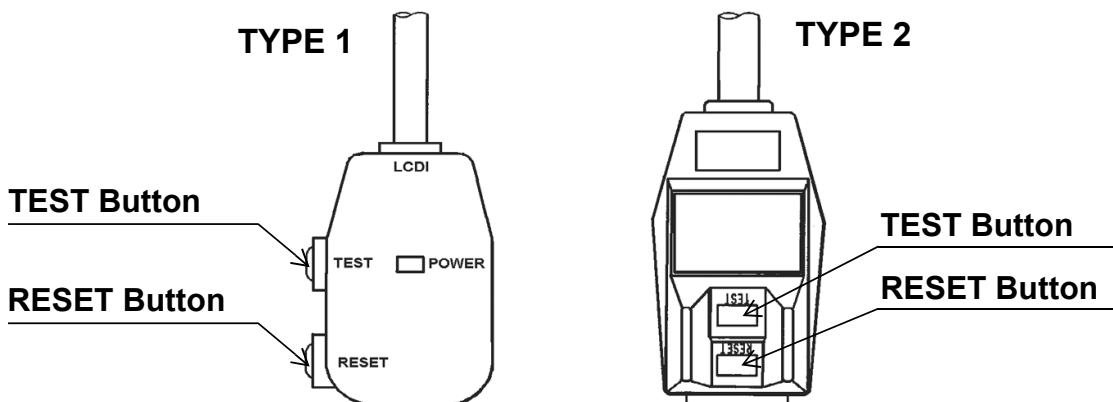

FEATURES

1. A digital electronic control panel, which allows the user to easily control the unit's operation.
2. Digital LED display that indicates:
 - a. Room temperature and set point temperature (either Fahrenheit or Celsius)
 - b. Status codes
3. The set point temperature can be adjusted between 70 °F (21 °C) and 95 °F (35 °C) by the SET TEMP buttons (Δ/∇).
4. Fire alarm control panel connection with automatic shut off.
5. Automatic shut off, warning signal output and alarm for temperature sensor failure and tank full.
6. A condensate drain "FL" is displayed by the LED.
7. An automatic restart feature when the power is lost and regained. The unit returns to the operating mode it was in prior to the loss of power.

OPERATION

Control Panel

Before operating the unit, it is important to familiarize yourself with the basic controls located on the control panel.

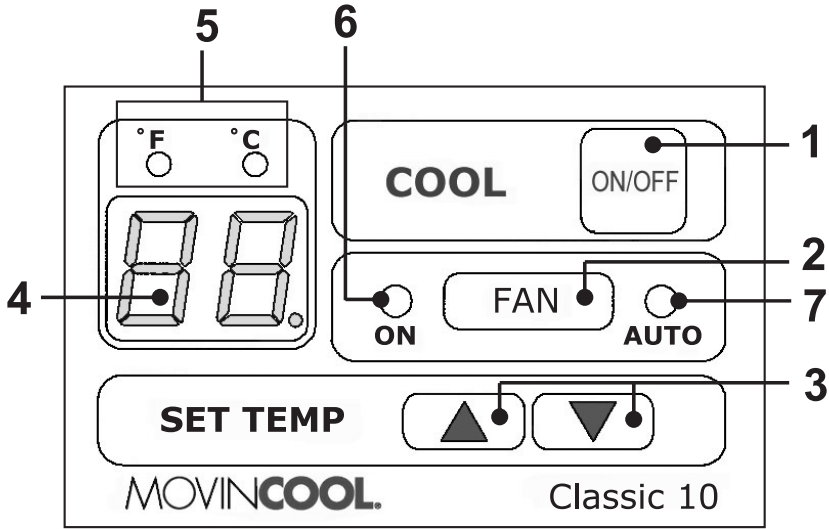

- | | |
|---|--|
| 1. COOL ON/OFF Button | Activates COOL mode or turns the unit off. |
| 2. FAN Button | Activates FAN ONLY mode or turns the unit off. |
| 3. SET TEMP Buttons (Δ/∇) | Increases or decreases the temperature set point during COOL mode. |
| 4. Room Temperature/ Set Point Display | Displays a flashing set point temperature for 5 sec, and then continuously indicates the room temperature. |
| 5. Temperature Scale LED | Lit to indicate the current temperature being displayed in either °F or °C. |
| 6. ON LED | Turns on during FAN ONLY mode and during COOL mode with Fan Operate mode. |
| 7. AUTO LED | Turns on during COOL mode with FAN STOP mode. |

OPERATION (cont.)

Control Panel (cont.)

LED Display Descriptions

In normal operation, the LED displays the following descriptions.

Display	Descriptions	Conditions
.	Right decimal point is on.	Standby or FAN ONLY mode.
78	Indicates room temperature when display is lit. (Left fig. : Room temperature at 78 °F)	During COOL mode.
75	Indicates set point temperature when display is flashing for 5 sec. (Left fig. : Set point temperature at 75 °F)	During set point temperature adjustment.

Note: The ROOM TEMP display range is from 0 °F (-9 °C) to 109 °F (60 °C). When the display value is greater than 99 °F, it displays values of 00 for 100 °F, 01 for 101 °F, and 09 for 109 °F. (This only applies to Fahrenheit values.)

OPERATION (cont.)

Operating in COOL Mode

1. The unit can be operated in COOL mode by pressing the COOL ON/OFF button.

Note: In COOL mode the unit can only be turned off by pressing the COOL ON/OFF button.

2. Change the temperature set point by pressing the SET TEMP buttons (Δ/∇).

Note: When turning the unit on, the set point and operation mode are determined by the last operating mode.

OPERATION (cont.)

Operating in FAN ONLY Mode

1. The unit can also be operated in FAN ONLY mode by pressing FAN button.
2. The unit can only be turned off by pressing the FAN button again.

Changing from FAN ONLY Mode to COOL Mode

The COOL mode can be activated while the unit is operating in FAN ONLY mode. To do this, simply press the COOL ON/OFF button.

Note: The FAN ONLY mode does not operate after the COOL mode has been activated. The unit can only be turned off by pressing the COOL ON/OFF button.

OPERATION (cont.)

Operating Modes

The Classic 10 and Classic 18 can be operated in two modes, FAN ONLY and COOL. When in FAN ONLY mode, the unit circulates the surrounding air. When in COOL mode, the compressor is operated and cool air is circulated.

1. COOL Mode

Once the compressor has been disengaged for more than 120 sec, the unit operates in FAN ONLY mode for approximately 5 sec before the compressor re-engages (see page 28).

2. Temperature Control

The room temperature thermistor monitors the inlet temperature versus set point temperature and switches the unit automatically between COOL and FAN ONLY modes.

3. Fan Mode Control DIP Switch

The fan mode control DIP switch determines whether the fan continues to operate or stop when the compressor cycles off. (Set point temperature below the inlet air or room temperature.) The unit has been preset at the factory for continuous fan operation.

Note: If you want to change the fan mode operation (from OPERATE to STOP), contact your MovinCool reseller.

4. Temperature Scale Display





The temperature scale display changes the temperature(s) that are displayed to either °C or °F. The unit has been preset from the factory to display the temperature(s) in °F.

Note: If you want to change the temperature scale display (from °F to °C), hold down the SET TEMP buttons (△/▽) and the FAN button simultaneously for 3 sec.

OPERATION (cont.)

Self-Diagnostic Codes

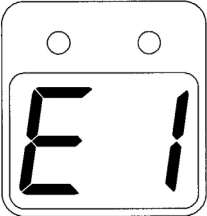
Self-diagnostic codes are displayed on the control board under the following conditions:

LED Display Codes	Condition
	<p>When the drain tank switch is activated, the LED displays “FL” and the unit turns off automatically. Once emptying the drain tank procedure is completed and ON/OFF has been pressed, unit returns to normal operation.</p>
	<p>When the drain pump malfunctions, the compressor shuts off, and the LED displays “AS”. Once drain pump is fixed and unit has been RESET, the unit returns to normal operation.</p> <p>To RESET: Hold down the SET TEMP (Δ/∇) buttons simultaneously for 3 sec, and the controller returns to normal operation.</p>
	<p>When room thermistor becomes open or shorted, display shows “E1” and cool mode operation is off. Display and cool mode operation are returned to normal operation after room thermistor is fixed. Contact your MovinCool reseller or a qualified technician if problem persists.</p>
	<p>When freeze thermistor becomes open or shorted, display shows “E2” and cool mode operation is off. Display and cool mode operation are returned to normal operation after freeze thermistor is fixed. Contact your MovinCool reseller or a qualified technician if problem persists.</p>
	<p>When the fire alarm control panel input signal is CLOSED, the unit turns off, the LED displays “AL”, and the buzzer turns on. Once input signal is OPENED and unit has been RESET, the unit returns to normal operation.</p> <p>To RESET: Hold down the SET TEMP (Δ/∇) buttons simultaneously for 3 sec, and the controller returns to normal operation.</p>

OPERATION (cont.)

Empty the Drain Tank

During COOL mode, condensate water accumulates in the drain tank. When the drain tank becomes full, the LED displays “FL” and the unit turns off automatically.

Note: If you want to empty the drain tank, while the unit is in operation, press the COOL ON/OFF button to turn the unit off.

1. Pull the drain tank from the unit.

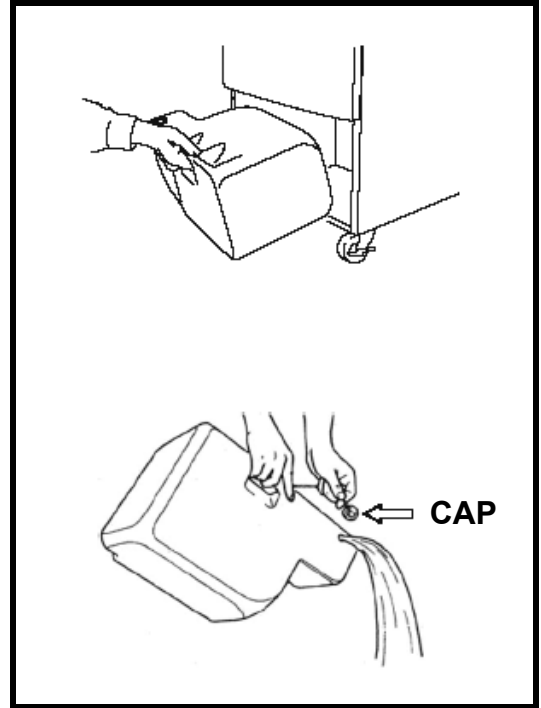

2. Remove the cap and empty the drain tank.

3. Replace the cap and return the drain tank to the unit.

4. Press the COOL ON/OFF button to restart the unit.

OPERATION (cont.)

Condensate Pump Kit (Optional for Classic 10)

A condensate pump kit is available to allow continuous operation and to eliminate the need for a drain tank.

When the water collects to level (A) in the pump reservoir, the condensate pump begins to operate and discharge the water.

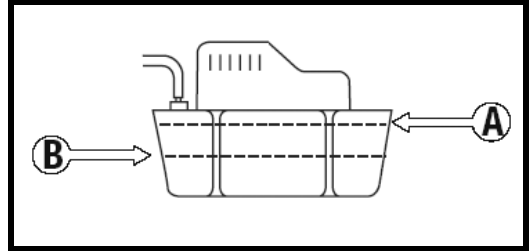

Note: The compressor does not operate while the condensate pump is discharging the water.

When the water level drops below level (B), the condensate pump stops, and the compressor restarts.

Note: If for any reason the water level exceeds that of level (A) in the pump reservoir, an over flow drain switch stops the compressor operation, and the LED displays "AS".

Note: If the fan mode control DIP switch (see page 20) is set to the STOP position, the entire unit (including fan operation) turns off either due to the over flow drain switch or while the condensate pump is discharging the water.

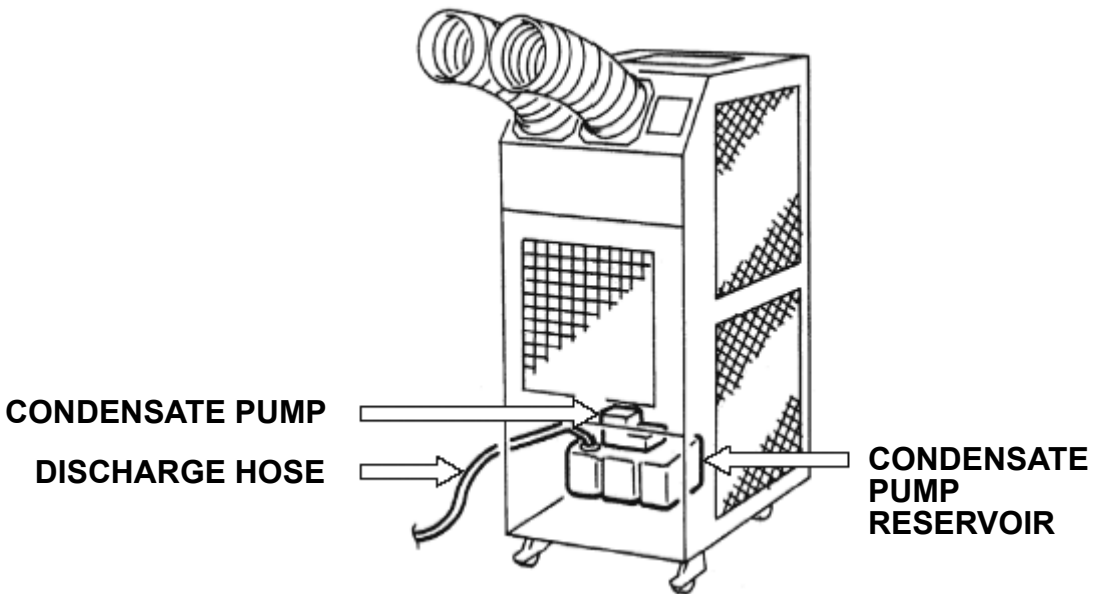

OPERATION (cont.)

Condensate Pump Kit (Optional for Classic 18)

A condensate pump kit is available to allow continuous operation and to eliminate the need for a drain tank.

When the water collects to level (A) in the pump reservoir, the condensate pump begins to operate and discharge the water.

When the water level drops below level (B), the condensate pump stops.

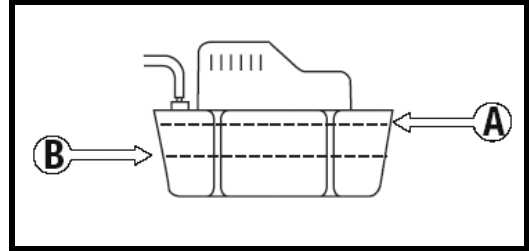

Note: If for any reason the water level exceeds that of level (A) in the pump reservoir, an overflow drain switch stops the compressor operation, and the LED displays “AS”.

Note: If the fan mode control DIP switch (see page 20) is set to the STOP position, the entire unit (including fan operation) turns off due to the over flow drain switch.

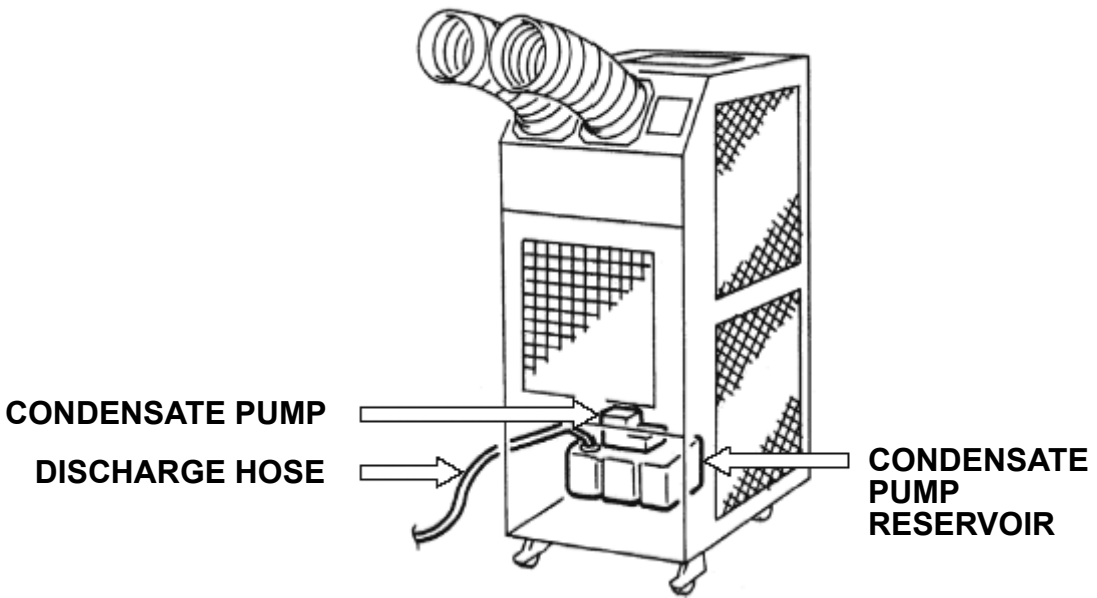

DAILY INSPECTION & MAINTENANCE

Empty the Drain Tank

To empty the drain tank, refer to instructions on page 22.

Clean the Air Filters

Clean the air filters once a week. If the unit is used in a dusty environment, more frequent cleaning may be required.

A dirty air filter can reduce air output resulting in a decrease in cooling capacity.

Filter Removal Method

1. Turn the unit off, by pressing the COOL ON/OFF button.
2. Remove the air filters.

Note: To remove the side air filters, lift upward, then pull outward from the bottom. To remove the front panel air filter, pull out top corners, then lift upward.

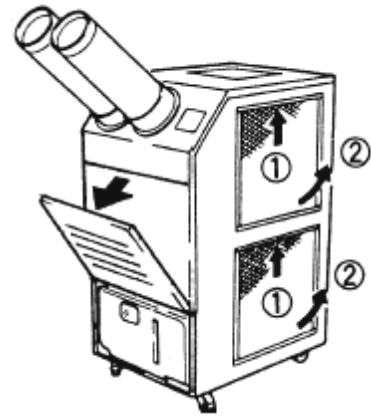

3. Remove the element from each filter.

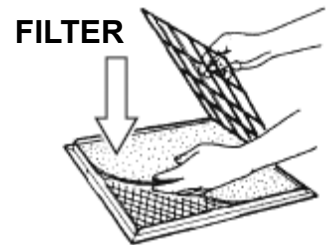

Filter Element Cleaning Method

1. Remove dust from the element with a vacuum cleaner, or rinse in cold or lukewarm water. If the element is extremely dirty, wash with a neutral detergent.
2. After the element has been cleaned, rinse with clean running water, allow to dry, then reinstall.

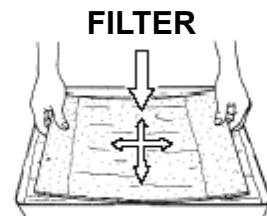

DAILY INSPECTION & MAINTENANCE (cont.)

In-Season/Off-Season Inspection & Maintenance

In-Season

1. Check the prongs and surface of the power cord plug for dust and/or dirt. If dust and/or dirt are present, wipe off with a clean dry cloth.
2. Check the power cord, plug and prongs for damage or excess play. If any damage or excess play is found, contact your MovinCool reseller or a qualified technician for repair.
3. Check the air filters and drain tank.
4. Clean the outside of the unit(s) with a damp cloth or mild nonabrasive cleaner.

Off-Season

1. Operate the unit in FAN ONLY mode for 8 hr.
Note: Operation is necessary to dry out the inside of the unit.
2. Disconnect the power cord from the AC outlet.
3. Check the prongs and surface of the power cord plug for dust and/or dirt. If dust and/or dirt are present, wipe off with a clean dry cloth.
4. Check the power cord, plug and prongs for damage or excess play. If any damage or excess play is found, contact your MovinCool reseller or a qualified technician for repair.
5. Clean the air filters.
6. Empty all water from the drain tank.

TROUBLESHOOTING

Check the following items before calling your MovinCool reseller or a qualified technician.

SYMPTOM	POSSIBLE CAUSE	REMEDY
Unit does not operate.	1. Ground fault breaker trip or LCDI power cord trip.	Reset breaker or reset power cord.
	2. Drain tank is full. LED displays "FL".	Empty the drain tank.
Insufficient cooling.	1. Dirty/Blocked air filters.	Clean air filter.
	2. Air inlet/outlet blocked.	Clean air inlet/outlet.
	3. Improper temperature setting.	Adjust temperature setting.

If symptoms persist after the above actions have been taken, turn the unit off, disconnect the power cord plug and contact your MovinCool reseller or a qualified technician.

TECHNICAL SPECIFICATIONS

ITEMS/FEATURES	Classic 10	Classic 18
Rating Conditions Dry bulb Wet bulb Humidity	95 °F(35 °C) 83 °F(28 °C) (60 %RH)	95 °F(35 °C) 83 °F(28 °C) (60 %RH)
Specifications Power frequency Line voltage Power consumption Current consumption Power factor Starting current Power wiring	60 Hz Single Phase 115 V 1.05 kw 9.7 A 96 % 43 A 14 (3-core) AWG	60 Hz Single Phase 208/230 V 1.90/1.90 kW 9.1/8.8 A 99/96 % 38/40 A 14 (3-core) AWG
Cooling Unit Cooling capability Cooling system	10,000 Btu/h (2,930 W) Direct Expansion	18,000/18,000 Btu/h (5,290/5,290 W) Direct Expansion
Blower Type of fan Air volume: Evaporator Condenser Motor output	Centrifugal Fan 265 CFM (451 m³/h) 740 CFM (1,258 m³/h) 0.14 kW	Centrifugal Fan 510/530 CFM (867/901 m³/h) 1,100/1,180 CFM (1870/2006 m³/h) 0.29 kW/0.35 kW
Compressor Type Output Refrigerant type Refrigerant capacity	Hermetic Rotary 0.70 kW R-410A 1.21 lb (0.55 kg)	Hermetic Rotary 1.12 kW R-410A 1.76 lb (0.80 kg)

TECHNICAL SPECIFICATONS (cont.)

ITEMS/FEATURES	Classic 10	Classic 18
Safety Devices Compressor overload protector Fan motor protector Anti-freezing thermistor Full drain tank switch Automatic restart (power interruption) Compressor time delay High pressure interruption Signal input/output	Included Included Included Included Included 120 sec N/A Included	Included Included Included Included Included 120 sec N/A Included
Dimensions & Weight W×D×H Weight	19.4 × 26.5 × 41.5 in 493 × 673 × 1,054 mm 149 lb (68 kg)	19.4 × 26.5 × 41.5 in 493 × 673 × 1,054 mm 164 lb (74 kg)
Operating Conditions Inlet air: Maximum Minimum	104 °F (40 °C), 50 %RH 70 °F (21 °C), 50 %RH	104 °F (40 °C), 50 %RH 70 °F (21 °C), 50 %RH
Control Device Temperature control Programmable timer Two speed fan	Included N/A N/A	Included N/A N/A



LIMITED WARRANTY

DENSO SALES CALIFORNIA, INC. (“DENSO”) warrants its MOVINCOOL Products only to the extent stated in its official written warranties. Unless otherwise specifically provided in writing by DENSO, DENSO warrants to end-user that the Products shall be free of defects in materials or workmanship and will function in accordance with DENSO’s published specifications under ordinary intended use and service for a period of twelve (12) months after delivery to the end-user; provided, however in the case of the compressor element of the Products such warranty shall be for a period of thirty six (36) months after delivery to the end-user. DENSO shall, at its sole option, repair or replace any defective Product covered by this warranty. Such remedy shall be end-user’s sole remedy with respect to any particular defect in the Products.

This warranty does not cover defects or malfunctions which result from causes beyond DENSO’s control, including, without limitation, (i) unusual physical or electrical stress; (ii) accident, neglect, abuse, misuse or other abnormal use; (iii) failure to perform routine maintenance in accordance with DENSO’s recommended procedures; (iv) normal wear and tear; (v) repairs or attempted repairs by an unauthorized person; (vi) modifications or alterations to the Products; (vii) use with supplies or devices not supplied or approved by DENSO; or (viii) improper servicing. This warranty shall extend only to the original end-user and shall be void if any labels or other identifying marks permanently affixed to Products when shipped by DENSO are removed, altered, defaced or obliterated.

The aforesaid warranty is the only warranty made by DENSO with respect to the Products and is in lieu of all obligations or liabilities on the part of DENSO for damages arising out of or in connection with the sale, use or performance of the Products, including, without limitation, any lost profits or any other consequential, incidental, special or exemplary damages of any kind.

DENSO DISCLAIMS ALL OTHER WARRANTIES WITH REGARD TO THE PRODUCTS, INCLUDING ALL IMPLIED WARRANTIES OF MERCHANTABILITY AND FITNESS FOR USE. THERE ARE NO WARRANTIES WHICH EXTEND BEYOND THE DESCRIPTION CONTAINED HEREIN.

PURCHASE DATE: _____

SERIAL NUMBER: _____

DENSO

DENSO SALES CALIFORNIA, INC.

Long Beach, CA 90810

www.movincool.com

P/N: 484007-2950EN

First Issue: January 2009